



DESCRIPTION



2.5" / DN50/65, 3" / DN80 and
4" / DN100 models

FlowVis® is a revolutionary, patented solution for accurate and reliable flow rate measurement in fresh water applications such as swimming pools, spas, fountains, water features, and solar systems.

Using a design that is based on 'mass flow' principles, the FlowVis® provides many benefits that include:

- Ease of installation without the need to have 15x of straight pipe
- Installation flexibility that allows orientation in any position, e.g., horizontal, vertical or even upside-down
- Long life without sticking floats or paddle wheels
- Combined Flow Meter and Check Valve in all models except FV-C-S, FV-3, FV-L-DN80, FV-4 and FV-L-DN100.

CONCEPT

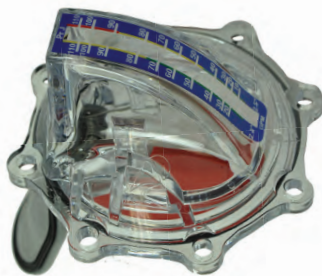

FlowVis® retrofit model

As flow increases, the check valve or safety flapper moves forward toward its fully open position. The flapper's angular position is directly related to flow rate through the valve body / Tee. A calibrated scale on the valve's lid provides a highly accurate reading of the flow rate.

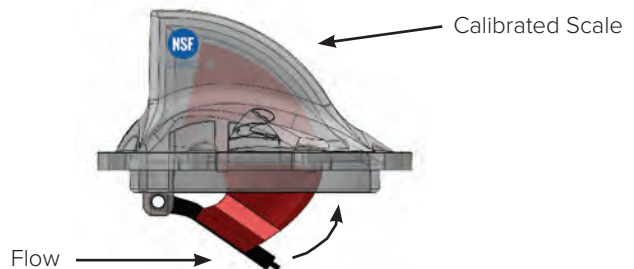

RESOURCES

Thank you for purchasing the H2flow FlowVis® flow meter. If you would like to find additional product resources, including tech tip sheets, brochures, videos, and materials in other languages, please visit our website at www.h2flow.net or scan the QR Code below.



SERVICE REPAIR KIT

A service repair kit is available using the Part Number FV-SK. The kit comprises:

- 1 x o-ring
- 1 x spring
- 1 x flapper and indicator arm (for all models except FV-C-S, FV-3, FV-L-DN80, FV-4 and FV-L-DN100)
- 1 x pivot pin

For all other parts, please contact H2flow at 888-635-0296 (toll-free) or (+1) 419-841-7774 (International).

TABLE OF CONTENTS

Description	front cover
Concept.....	front cover
General Info	
Resources.....	2
Service Repair Kit.....	2
Models & Compatibility	
Models.....	3
Compatibility.....	3
NSF 50.....	3
Safety Information	
Chlorine Feeders	4
Warnings & Safety.....	4
Dimensions & Valve Body Feature	
Dimensions.....	5
Valve Body Feature.....	5
Installation	
Installation.....	6
Lid Assembly & Operation	
Tightening Lid Screws.....	7
Operation.....	7
Operation & Maintenance	
Operation - reading flow rate.....	8
Maintenance	8
Specifications	
Materials Used	9
Operational Data.....	9
Flow Range	9
Head Loss.....	10
Warranty	
Warranty	back cover
Contact Info.....	back cover

MODELS

FlowVis® comprises several models; it is important that you check that the model you are about to install is the correct one for your application.

MODEL	PIPE SIZE	PIPE SCHED.	SCALE	DESCRIPTION
FV-C	2" or 2.5"	40	GPM	Complete FlowVis® including valve body
FV-C-L-DN50/65	DN50/65	40	LPM	Complete FlowVis® including valve body
FV-C-15	1.5"	40	GPM	Complete FlowVis® including valve body
FV-C-L-DN40	DN40	40	LPM	Complete FlowVis® including valve body
FV-C-L	2" or 2.5"	40	LPM	Complete FlowVis® including valve body
FV-C-15-L	1.5"	40	LPM	Complete FlowVis® including valve body
FV-C-S	2" or 2.5"	40	GPM	FlowVis® including valve body, no check valve
FV-C-S-L	2" or 2.5"	40	LPM	FlowVis® including valve body, no check valve
FV-3	3"	80	GPM	Complete FlowVis® including Tee
FV-L-DN80	DN80	80	LPM	Complete FlowVis® including Tee
FV-3-L	3"	80	LPM	Complete FlowVis® including Tee
FV-4	4"	80	GPM	Complete FlowVis® including Tee
FV-L-DN100	DN100	80	LPM	Complete FlowVis® including Tee
FV-4-L	4"	80	LPM	Complete FlowVis® including Tee
FV-C-Saline	2"	40	GPM	FlowVis® for flotation tanks
FV-J-R	2" or 2.5"	40	GPM	Retrofit for existing Jandy® check valve body
FV-J-R-15	1.5"	40	GPM	Retrofit for existing Jandy® check valve body
FV-P-R	2" or 2.5"	40	GPM	Retrofit for existing Praher® check valve body
FV-P-R-15	1.5"	40	GPM	Retrofit for existing Praher® check valve body
FV-H-R	2" or 2.5"	40	GPM	Retrofit for existing Hayward® check valve body
FV-H-R-15	1.5"	40	GPM	Retrofit for existing Hayward® check valve body
FV-SK	N/A	N/A	N/A	Please refer to description on page 2 of this document

TABLE 1

COMPATIBILITY

When using the 'retrofit' models listed in **Table 1**, it is important to note that each manufacturer's valve body design has a unique hydraulic characteristic that will result in a specific FlowVis® calibration scale being required. It is therefore important that you select the correct FlowVis® model for the particular valve body that is installed in your system.

NSF 50

Models certified to NSF 50 will display the mark as shown below:

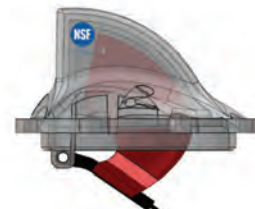

CHLORINE FEEDERS

IMPORTANT DISCLAIMER

Material selections such as Viton, Hastelloy C-276 and glass filled plastic ensure that FlowVis® will provide many years of trouble-free operation in normally treated, sanitized pool water conditions. However, certain brands and designs of inexpensive chlorine feeders are known to fail and release high concentrations of chlorine or even chlorine gas into the surrounding filtration system. When this occurs, any equipment that comes into contact with these abnormal levels of chemicals, will experience rapid and catastrophic damage. Inspection of any failed components will quickly and conclusively confirm the cause of the damage, and under these circumstances, the product's **warranty will be void.**

Under no circumstances should FlowVis® be used as a 'check valve' to prevent the effects of these Chlorine Feeders damaging other equipment such as Heaters.

Installation locations

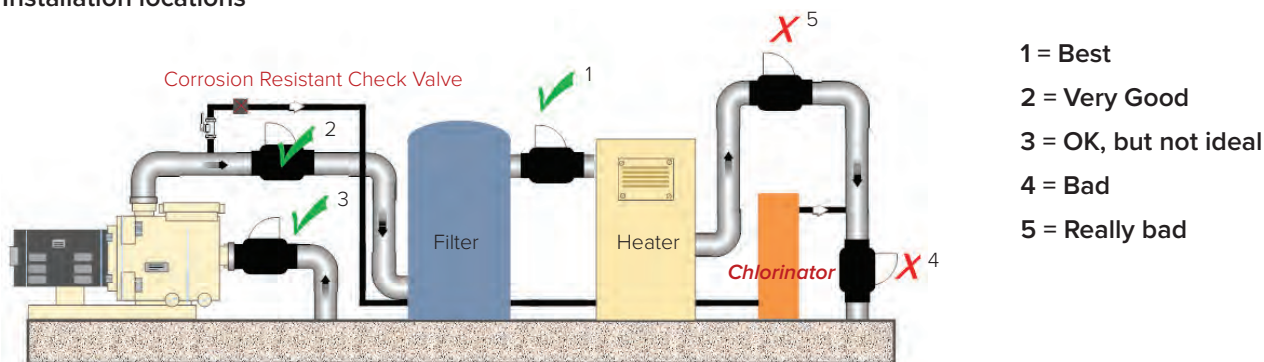

NOTE: The above graphic only relates to applications that use erosion style chemical feeders. In all other circumstances, the FlowVis® can be installed in any of the locations shown.

WARNINGS & SAFETY

Check Valves should always be installed in accordance with the original manufacturer's instructions. When purchased as a complete Check Valve & Flow Meter combination, a copy of these instructions will be included with the FlowVis® packaging. If a FlowVis® retrofit kit has been purchased, it is the installer's responsibility to ensure that the Check Valve has been installed correctly and does not violate any local or federal codes relating to Check Valves.

The Virginia Graeme Baker Pool & Spa Act requires that all public swimming pools & spas having a single main drain or multiple drains that are 3 feet or less (center to center) from each other be fitted with a backup anti-entrapment system. Such systems include, but are not limited to, SVRS and Automatic Pump Shut Off systems. Special consideration must be made when installing a FlowVis® to such applications. Several of these systems do not allow the use of Check Valves. It is the responsibility of the installer to make sure that the requirements of the specific backup system in use are maintained.



An optional non-sealing flapper is available for these installations. See Table 1 on page 3.

DIMENSIONS

MODEL	A	B	C	D	E	F	G	WEIGHT lbs / kg
FV-C-15, FV-C-15-L	6.5"	5.875"	Schedule 40 - 1.5"	1.875"	1.375"	4.63"	3.75"	1.5 lbs.
FV-C-L-DN40	165.1mm	149.23mm	Schedule 40 - DN40	47.63mm	34.93mm	117.6mm	95.25mm	0.544 kg.
FV-C, FV-C-S, FV-C-S-L, FV-C-Saline, FV-C-L	6.5"	5.875"	Schedule 40 - 2" slip and 2.5" with coupling	2.375"	1.375"	4.63"	3.75"	1.5 lbs.
FV-C-L-DN50/65	165.1mm	149.23mm	Schedule 40 - DN50 slip and DN65 with coupling	60.33mm	34.93mm	117.6mm	95.25mm	0.544 kg.
FV-3, FV-3-L	8.0"	9.5"	Schedule 80 - 3"	3.5"	1.875"	4.5"	4.25"	3 lbs.
FV-L-DN80	203.2mm	241.3mm	Schedule 80 - DN80	88.9mm	47.63mm	114.3mm	107.96mm	1.36 kg.
FV-4, FV-4-L	9.5"	9.75"	Schedule 80 - 4"	4.5"	2.25"	5.25"	5.00"	5 lbs.
FV-L-DN100	241.3mm	247.65mm	Schedule 80 - DN100	114.3mm	57.15mm	113.26mm	127mm	2.27 kg.

NOTE: Dimension C = pipe cutaway length.

FV-3, FV-3-L, FV-L-DN80, FV-4, FV-4-L, & FV-L-DN100:

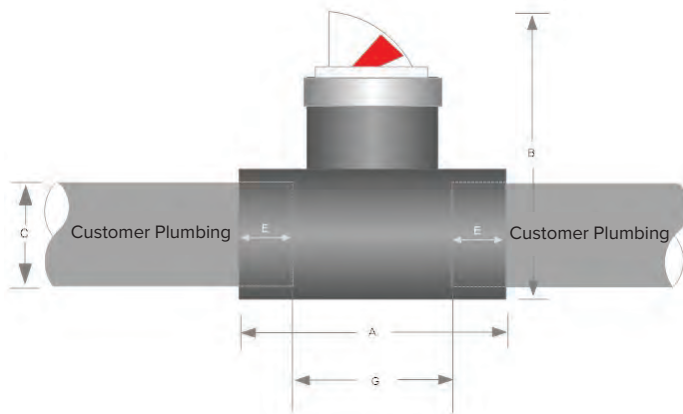

**FV-C-15, FV-C-L-DN40, FV-C,
FV-C-L, FV-C-L-DN50/65, FV-C-S,
FV-C-S-L, FV-C-Saline:**

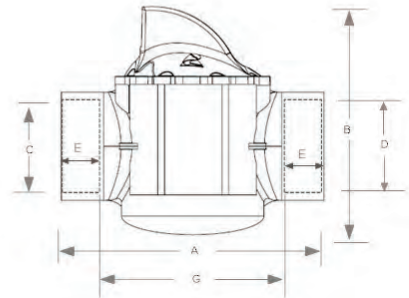

NOTE 3: Unlike other flow meters, all FlowVis® models can be installed directly next to other plumbing fittings such as elbows & tees, without the needs for 15x straight pipe diameters.

VALVE BODY FEATURE

On the side of the valve body that is used for the 1.5", 2"/2.5", DN40 and DN50/65 models, you will note the following feature:



This has no functionality relating to the operation of the FlowVis® and is simply provided as a feature to be able to plumb in a drain down pipe and valve. A typical use for this might be a roof mounted solar system. Under no circumstances should this hold be drilled out when using the valve body with the FlowVis®.

INSTALLATION

IMPORTANT NOTE: Before installing the FlowVis[®], please refer to the preceding section regarding chlorine feeders.

Installation of FlowVis[®] should be in accordance with the following instructions.

Normal plumbing procedures such as cleaning, priming and gluing of fixtures should be followed in order to avoid leaks. If you are not familiar with plumbing procedures, it is recommended that you employ the skills of a qualified plumber.

Unlike other flow meters, FlowVis[®] is not affected by flow stream disturbances caused by its proximity to pumps, elbows, tees, valves, etc. FlowVis[®] does not require specific straight pipe lengths before or after its point of installation, and can be installed close to, or even adjacent to other plumbing fittings. FlowVis[®] can be installed either horizontally or vertically.

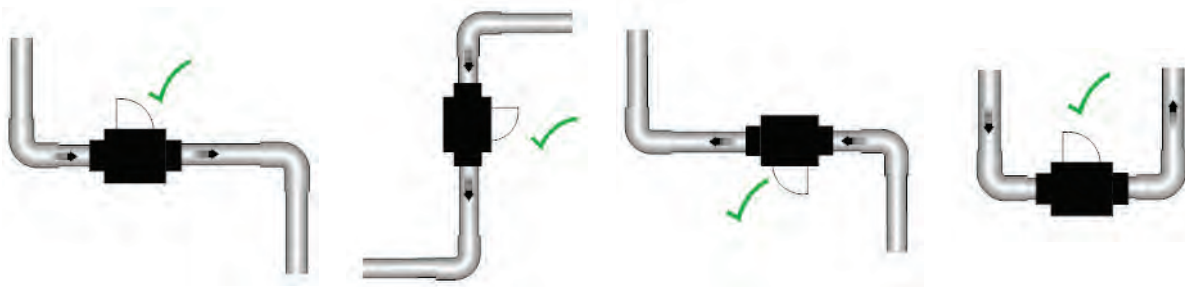

NOTE: When selecting a physical location to install FlowVis[®], be sure to allow accessibility to read the scale on the lid.

Pay particular attention to the system's direction of flow and make sure that the arrow on the lid of the FlowVis[®] is pointing in the correct direction. For the 3" / DN80 and 4" / DN100 versions, the Tee will have an additional arrow on one of its bosses. In the event that the FlowVis[®] is inadvertently glued into the plumbing in the wrong direction, simply remove the (8) screws holding the lid in place and rotate the entire lid assembly by 180°.

TIGHTENING LID SCREWS

When installing the Retrofit versions of FlowVis® or when removing and re-installing the FlowVis® lid assembly, it is important to adhere to the following procedure:

1. Make sure that the o-ring on the underside of the lid is undamaged, lubricated with silicone (such as Boss 820) and is in-place without twists.
2. Ensure flapper hinge pin is centered.
3. Carefully lower the lid onto its valve body (or Tee in the case of the 3" / DN80 and 4" / DN100 models), making sure that the o-ring stays in place.
4. Insert by hand the (8) stainless steel screws but do not tighten at this stage.
5. Using a hand Phillips-head screwdriver, slowly tighten the screws in a diagonal pattern, per the sequence to the right. Do not fully tighten one screw before proceeding to the next, i.e., pull them down slowly multiple times to avoid stressing and cracking the lid. Screws should be tightened to a final torque of 25 inch / pounds or 34 Nm.

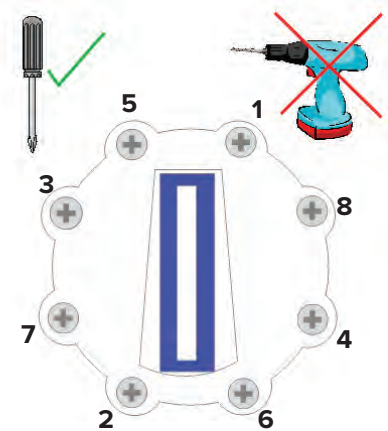

OPERATION

The FlowVis® is factory-calibrated to be extremely accurate across its full operating range. Any perceived 'inaccuracy' is related to the viewing angle at which the scale is being read. To avoid so-called 'parallax error', it is important to position your eye so that you are looking squarely at the tip of the indicator arm. To achieve this, simply move your head so that you just lose sight of the vertical leading edge of the red arm.

NOTE: Slowly move your head in this direction to the point where the leading edge of the indicating arm is not visible.

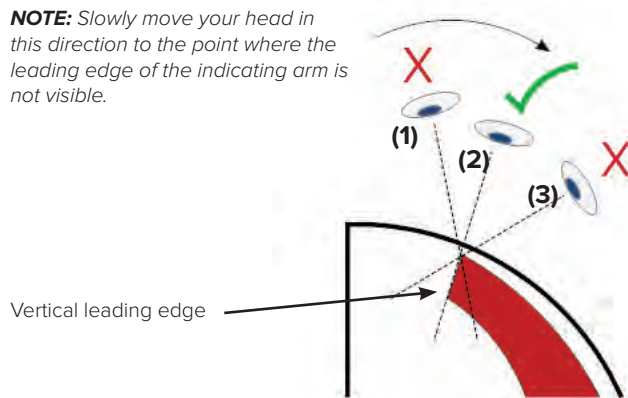

(1) Indicator arm is being viewed too far forward / near the rear of the lid.



(2) Indicator arm is being viewed correctly.

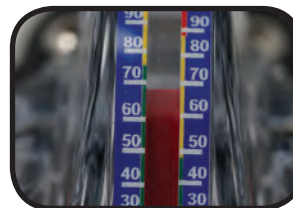

(3) Indicator arm is being viewed too far back / front of the lid.

OPERATION - READING FLOW RATE



The FlowVis® scale not only shows flow rate, but also an indication of velocity.

Alongside the flow rate values are green, yellow, and red bands; these relate to velocity rates of:

Color	Velocity (Feet Per Second)	Velocity (Meters Per Second)
Green	≤5	≤1.52
Yellow	5-9	1.53 - 2.73
Red	9≥	2.74≥

MAINTENANCE

Although FlowVis® is designed to be maintenance-free, periodic checks should be made to the following:

Condition	Check for	Remedy
Leak around lid seal	O-Ring Failure	Replace O-Ring
Leak from lid	Cracks in lid	Order new lid from supplier
Higher flow reading than normal	Broken or weak spring	Replace spring
Lower flow reading than normal	Indicator arm stuck due to debris	Remove lid and clear debris
Flow indicator stuck at one position	Debris between indicator arm and lid	Remove lid and clear debris
Indicator always at max flow when pump running	Broken spring	Replace spring
Flapper seal crinkled	Chlorinator check valve failure	Repair chlorinator, order FlowVis® Service Repair Kit. Consider moving FlowVis® to a different location (see 'Chlorine Feeders' section on pg. 4).

SPECIFICATIONS

Materials used:

Item	Material / Comments
Lid	Polycarbonate
Valve Body (1.5", 2", and 2.5")	CPVC
Lid Screws	304 Stainless Steel
O-ring	Silicone Lubricated Elastomer
Scale label, Product label, NSF label	Polycarbonate
Pivot Pin (model FV-C and metric equivalents)	Glass-filled plastic. Hastelloy C-276 post Feb. 2017
Spring	316 Stainless Steel. Hastelloy C-276 post Nov. 2015
3" / DN80 and 4" / DN100 Tee and reducing bushings	PVC
Indicator Arm	ABS
Flapper (1.5", 2", 2.5", and DN40, DN50/65)	PPEPS
Flapper Seal (1.5", 2", 2.5" and DN40, DN50/65)	Viton
Flapper (FV-C-S only)	ABS
Lower Flapper (3" / DN80 and 4" / DN100 only)	ABS
Interconnecting link (3" / DN80 and 4" / DN100 only)	316 Stainless Steel
Lower Retaining Pins (3" / DN80 and 4" / DN100 only)	316 Stainless Steel

Operational Data:

Function	Models	Comments
Max working pressure	All models	50 psi
Accuracy	FV-C / FC-C-S / FV-C-Saline	Average: 97.9% / 98% / 97.5%
Accuracy	FV-3, FV-4, FV-L-DN80 and FV-L-DN100	Average: 98.6% in straight pipe
Min / Max operating ambient temp	All models	32°F (0°C) / 140°F (60°C)
Periodic calibration	All models	None required
Design life	All models	Greater than 5 years

Flow Range:

FlowVis® Models	Pipe Size	Min Flow - GPM U.S.	Min Flow - LPM	Max Flow - GPM U.S.	Max Flow - LPM
FV-C-15, FV-J-R-15, FV-P-R-15, FV-H-R-15, FV-C-L-DN40	1.5"	10	40	90	360
FV-C, FVJ-R, FVP-R, FV-C-L-DN50/65	2" / 2.5"	10 / 20	40 / 80	110	400
FV-C-S, FV-C-S-L	2" / 2.5"	30	N/A	110	N/A
FV-3, FV-L-DN80	3"	90	N/A	220	833
FV-4, FV-L-DN100	4"	160	N/A	300	1136
FV-C-Saline	2"	20	80	100	400

SPECIFICATIONS

Head Loss (FV-C):

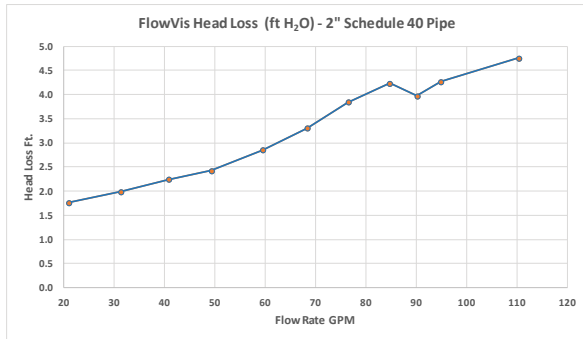

NOTE: One 90° elbow equals 5.7 feet

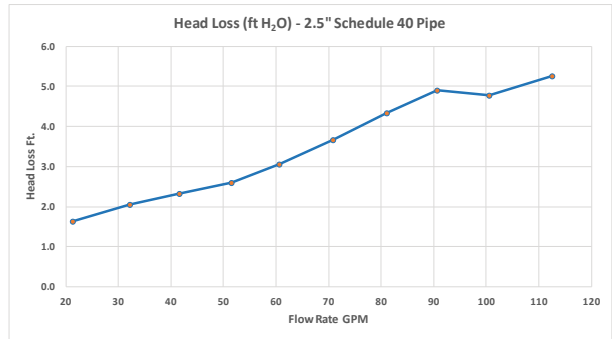

NOTE: One 90° elbow equals 6.9 feet

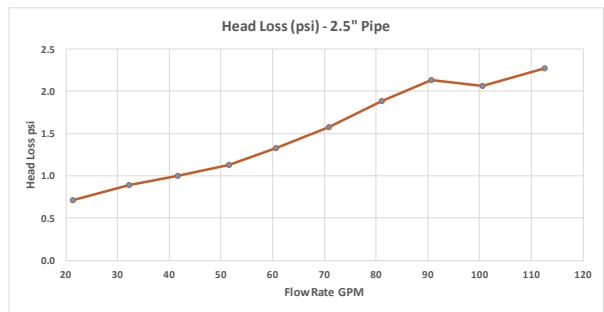
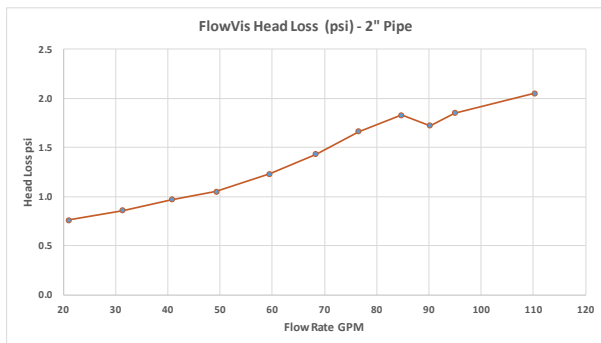

Head Loss (FV-C-S):

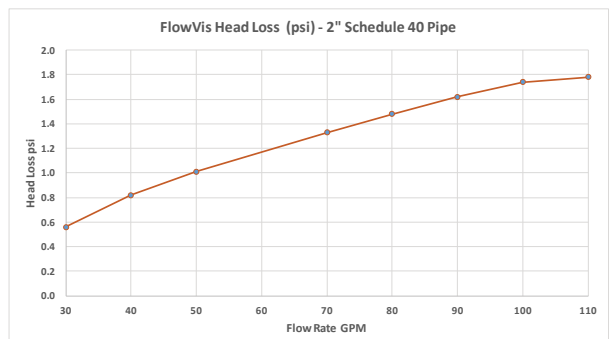
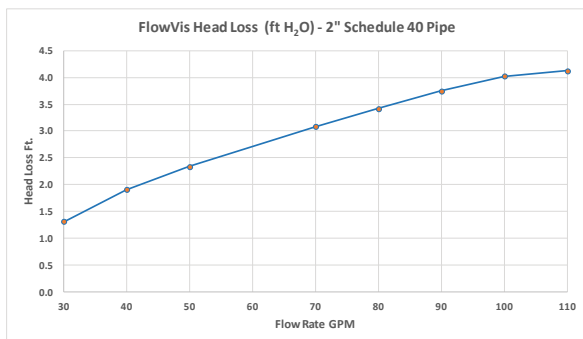

Head Loss (FV-C-Saline):

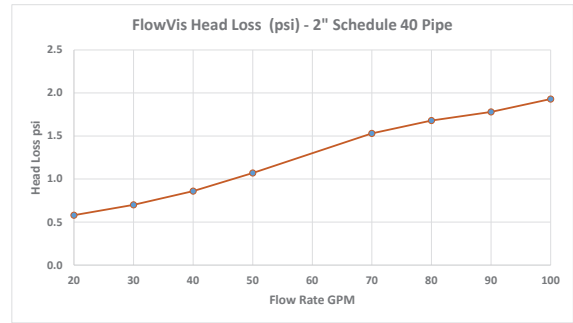
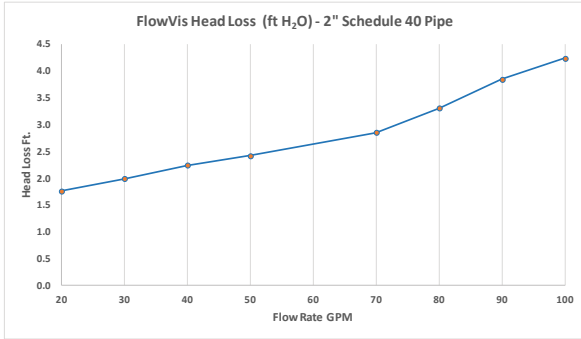

Head Loss (FV-3):

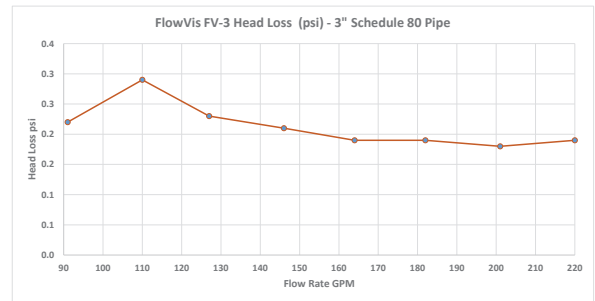
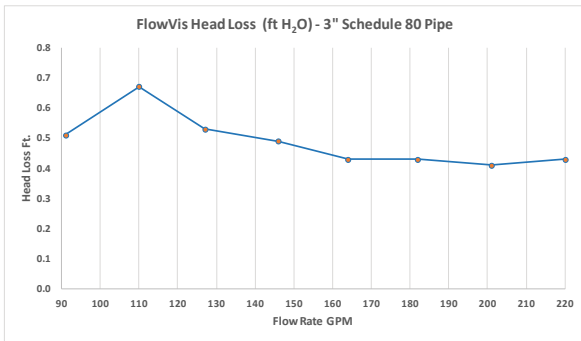

NOTE: One 90° elbow equals 7.9 feet

Head Loss (FV-4):

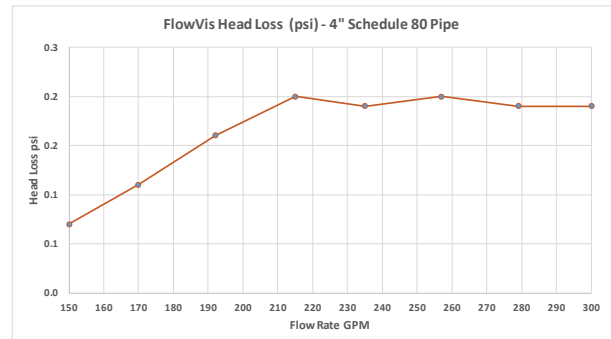
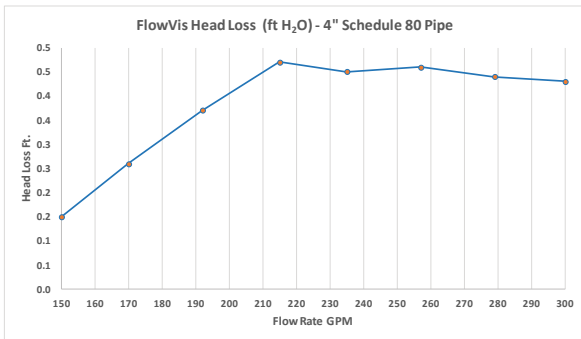

NOTE: One 90° elbow equals 11.4 feet

WARRANTY

IMPORTANT, please read and keep this document on record.

1. Definition

H2flow Controls, Inc., warrants the FlowVis® product for 3-years from its date of supply from H2flow Controls, Inc. or its stocking Distributor. In the event that the product experiences a premature failure due to defective workmanship or materials, H2flow will, at its discretion, replace either the failed component(s) or the complete FlowVis unit. H2flow shall not be responsible for third-party labor or any consequential losses. Damage caused by improper installation, misuse or exposure to excessive chemicals such as chlorine, will not be covered by this warranty.

2. Eligibility

This warranty extends to the original purchaser only or to the end-user client of an H2flow Controls Inc authorized affiliate.

3. How to obtain service

To obtain service under the terms of this warranty, the customer is required to notify H2flow Controls Inc. before the expiration of the warranty period and to return the item in accordance with H2flow Controls Inc's product return policy. Any product returned for warranty repair must be accompanied by a full fault report specifying the symptoms and the conditions under which the fault occurs. Should H2flow Controls Inc incur additional cost as a result of a failure to complete the appropriate paperwork, an administrative charge may be levied.

4. Exclusions

This warranty shall not apply to any defect, failure or damage caused by improper use or improper or inadequate care. H2flow Controls Inc. shall not be obligated to provide service under this warranty if:

- a) damage has been caused by a failure to make a full and proper inspection of the product (as described by the documentation enclosed with the product at the time of shipment) on initial receipt of the product following shipment;
- b) damage has been caused by the attempts of individuals, other than H2flow Controls Inc staff to repair or service the product;
- c) damage has been caused by the improper use of the product, including but not limited to, the installation of a FlowVis® unit using a chlorination system as described on page 4 of this manual.

5. Charges

Under cover of this warranty, H2flow Controls Inc will pay the carriage and insurance charges for the shipment of defective product back to H2flow Controls Inc and for its return to the client's original site of dispatch except when:

- a) H2flow Controls Inc's product return policy has not been followed.
- b) product failure is caused by any of the exclusions described at paragraph 4 above, when the customer will be liable for the full cost of the repair (parts and labor) plus all carriage and insurance costs to and from H2flow Controls Inc's premises.
- c) the product is damaged in transit and a contributory cause is inadequate packaging. It is the customer's responsibility to ensure that the packaging used to return equipment to H2flow Controls Inc is the same, or has equivalent protective qualities, to that used to ship the product to the customer in the first instance. Any damage resulting from the use of inadequate packaging will nullify H2flow Controls Inc's obligations under this warranty.

Should the customer's product be damaged in transit following a repair at H2flow Controls Inc's site, a full photographic record of the damage must be obtained (packaging and the product) to support any claim for recompense. Failure to present this evidence may limit H2flow Controls Inc's obligations under this warranty.

THIS WARRANTY IS GIVEN BY H2FLOW CONTROLS INC IN LIEU OF ANY OTHER WARRANTIES, EXPRESSED OR IMPLIED, INCLUDING BUT NOT LIMITED TO ANY IMPLIED WARRANTY OF MERCHANTABILITY, NON INFRINGEMENT OR FITNESS FOR A PARTICULAR PURPOSE. H2FLOW CONTROLS INC SHALL NOT BE LIABLE FOR ANY SPECIAL, INDIRECT, INCIDENTAL OR CONSEQUENTIAL DAMAGES OR LOSSES. WE SPECIFICALLY DISCLAIM ANY AND ALL WARRANTIES TO CUSTOMERS OF THE CUSTOMER. THE CUSTOMER'S SOLE REMEDY FOR ANY BREACH OF WARRANTY IS THE REPAIR OR REPLACEMENT, AT H2FLOW CONTROLS INC'S DISCRETION, OF THE FAILED PRODUCT.



H2flow Controls, Inc., 3545 Silica Road, Unit F, Sylvania, OH 43560 U.S.A.
Tel: 888-635-0296 (Toll Free) OR (+1) 419-841-7774 (International) • Fax: 419-517-9900
For international sales and service, please visit our website: www.h2flow.net