

RANGER AT POOL LIFT

US PATENT NO'S: [7,249,386 B2] [D507,769 S]

MEASUREMENT TAKEN WITH THE LIFT AT FULL LOAD

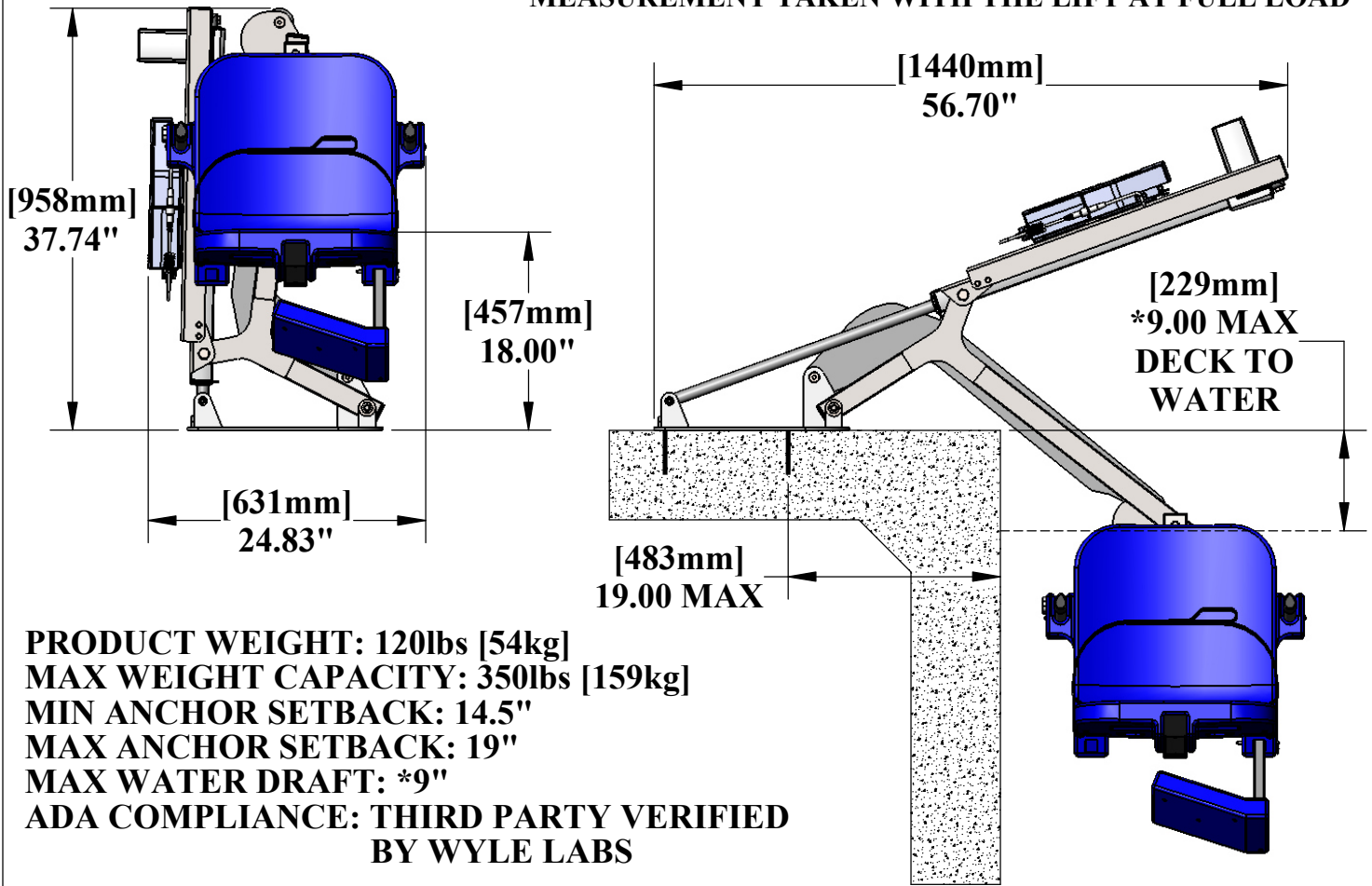

PRODUCT WEIGHT: 120lbs [54kg]
MAX WEIGHT CAPACITY: 350lbs [159kg]
MIN ANCHOR SETBACK: 14.5"
MAX ANCHOR SETBACK: 19"
MAX WATER DRAFT: *9"
ADA COMPLIANCE: THIRD PARTY VERIFIED BY WYLE LABS

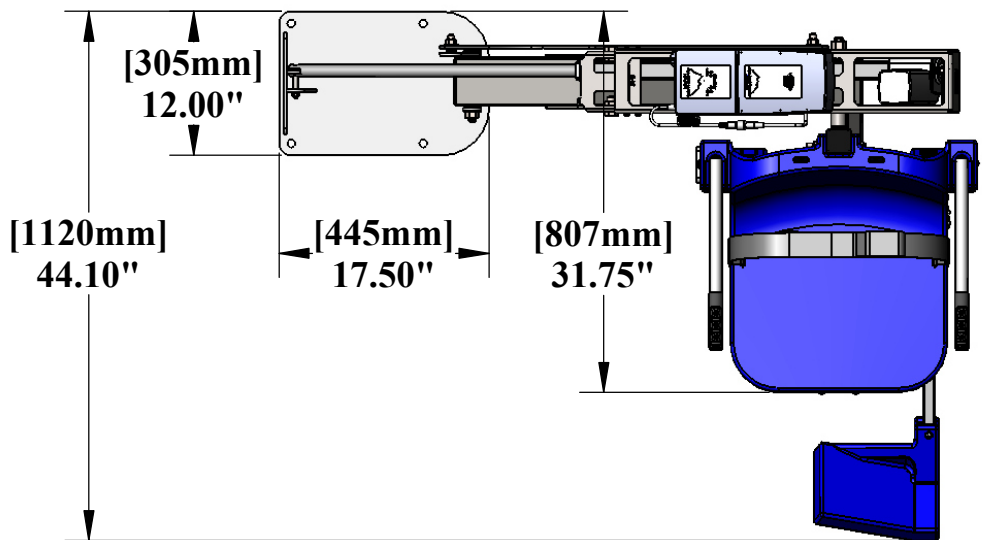

Inspected And Verified To Meet
 Applicable Sections of ADA
 Guidelines Section 1009.2 By

wyle
 laboratories

A Registered ISO 9001
 Laboratory



9889 GARRYMORE LANE
 MISSOULA, MT 59808
 (406) 549-0769
 FAX (406) 549-2602

NOTE:
 *SPECIFICATIONS ARE SUBJECT TO CHANGE WITHOUT NOTICE

PRODUCT:		F-411RPL-AT1	
DWG #:		1 OF 1	
SCALE:	1:16	DATE:	12/9/2016
DRAWN BY:	EF	REVISION:	A