

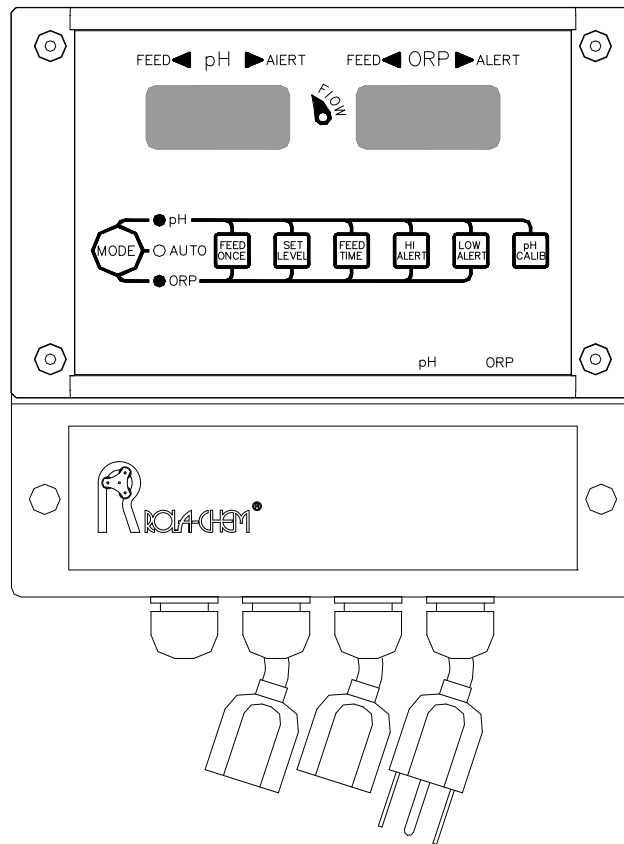

# MODEL 554000 ORP/pH Digital Controller



## Operating Manual

# QUICK START REFERENCE

Use this section for reference - please read all safety instructions and appropriate manual sections for installation and operation instructions.

## On/Off:

- Press the mode button to turn the unit on. Note: 'FLOW' light must illuminate.
- Press and hold the mode button to turn the unit off.
- "OFF" will be displayed in the windows

## To Operate:

- Press and release the mode button until the "AUTO" LED is lit.
- Unit will now operate in the factory preset settings:
  - Set levels: ORP = 650 mV, pH = 7.4
  - Feed times: 0.6 second feed with a 5 minute delay
  - Limits: ORP; 900 hi, 100 low, pH; 8.0 hi, 7.0 low

## To Change Settings:

Note: Press and release the mode button until the desired ORP or pH LED is lit.

Once the settings are changed, they will remain at those settings until they are changed again.

- Set level: press the Set Level button until the desired set point is reached. Release the button.
- Feed time: press the Feed Time button until the desired feed time is reached.

Release the button.

The numbers represent the seconds of feed time (all with 5 minute delays).

Range is 0.6 to 900 sec. (15 min.).

Constant feed is 'con'. Factory setting is 0.6 sec.

- Hi alert: press the Hi Alert button until the desired level is reached. Release the button
- Low alert: press the Low Alert button until the desired level is reached. Release the button.

## Manual Feed:

- Press and release the mode button to light the LED associated with the desired feeder to be manually fed, ORP or pH.
- Press the "feed once" button. The desired feeder will go through one "set feed" time cycle. There is no manual feed option when the unit is in constant feed.

**Other:** See the appropriate manual sections for--

- setting the time out feature
- calibrating the pH sensor
- changing dip switches (pH/ORP interlock, feeder time out, acid/base, and lockout).

# Table of Contents

<b>Section title</b>	<b>Page</b>
Quick Start Reference	2
1.0 Safety Instructions	4
2.0 Description and Specifications	
2.1 General Description	4
2.2 Specifications	6
2.3 Description of controls	7
3.0 Installation	
3.1 Locating the controller	10
3.2 Mechanical installation	10
3.3 Power access panel	11
3.3.1 Dip switches	11
3.3.2 Fuses	11
3.3.3 Flow switch	11
4.0 Operation	
4.1 Startup	12
4.2 PH settings	12
4.3 ORP settings	13
4.4 Operating mode	13
5.0 Troubleshooting	13
6.0 Warranty	15
7.0 Appendix	
7.1 Dip switch setting	16
7.2 Factory default settings	17
7.3 Water Chemistry Ranges-NSPI	17
7.4 Typical system installations	18

## 1.0 Safety Instruction

- A- **WARNING:** Do not shut down circulating and control system immediately after using pool, spa or hot tub. Systems must operate until water chemistry is stable. Systems must be restarted before water chemistry is out of NSPI recommended ranges or water chemistry must be manually corrected.
- B- **WARNING:** Removing power from circulating pump must also remove power from the controller. Provide a properly located outlet controlled by the circulating pump circuit.
- C- **WARNING:** Pool water must be balanced and stabilized before operating this controller. (See 'READ ME FIRST' document for further information.)
- D- **WARNING:** Use a device such as a flow switch to shut-off power from the controller in the event of pool pump or circulation failure. It is not safe to automatically dispense chemicals into a circulating system that is not running.
- E- **WARNING:** Controller uses microprocessor.  
Wireless communication equipment or other electrical operated devices operated in close proximity may cause inadvertent actuation of chemical feed pumps.
- F- **WARNING:** Risk of electric shock.  
Connect power cord to ground-fault circuit interrupter (GFCI). Contact qualified electrician if you can not verify that your installation meets local electrical codes, including grounding of water system components.
- G- **WARNING:** Do not bury cords.  
Locate cord to minimize abuse from lawn mowers, trimmers and other equipment. Replace damaged cords immediately. Do not use extension cords.
- H- **WARNING:** Do not install within an outer enclosure or beneath skirt of tub or spa unless so marked.

## 2.0 Description and Specifications

### 2.1 General Description

The controller is a microprocessor-based chemical automation system, which continuously monitors and maintains the pH balance and sanitizer level in a swimming pool or spa.

The pH and sanitizer level (ORP) are displayed using sun-bright seven-segment light emitting diodes. The pH and ORP levels are continuously monitored and displayed on the controller's front panel. The ORP/pH controller has been designed to be user friendly. One MODE button and six SET buttons allow the operator to easily set parameters.

The pH display range is 6.8 to 8.2 with a .1 unit resolution. The pH set point is adjustable from 7.0 to 8.0 in .1 pH steps, with a factory default set point of 7.4 pH. During a pH feed cycle, the pH feed lamp will blink when pH chemicals are being feed and illuminate continuously during the feed delay portion of the feed cycle. The pH Alert lamp will illuminate when the pH reading is higher or lower than the high and low pH Alert set points and prevent the feeding of pH chemicals.

The sanitizer (ORP) display range is 0 to 995 mV with a 5 mV display resolution. The ORP set point is adjustable from 400 to 900 mV, with default set point of 650 mV. During an ORP feed cycle, the ORP feed lamp will blink when sanitizer chemicals are being feed and illuminate continuously during the feed delay portion of the feed cycle. The ORP Alert lamp will illuminate when the ORP reading is higher or lower than the high and low ORP Alert set points and prevent the feeding of sanitizer chemicals.

A manual feed cycle for pH or ORP can be started by pressing the Mode button (placing the controller in stand-by mode for either pH or ORP) and then pressing the Feed Once button.

The feed cycle is a timed based ‘feed then delay’ system. The controller has a series of fixed feed times (0.6 to 900 sec.) with associated delays as well as a constant feed mode. A feed cycle consists of a feed time plus a delay time. Example, a 30 second feed time followed by a five-minute delay would have a 5½ minute feed cycle. The chemical feeder dispenses chemical only during the feed time portion of the cycle and then waits for a delay period to allow for chemical to dispense throughout the swimming pool or spa.

The controller incorporates an internal non-volatile memory in which all factory default settings as well as field-modified settings are stored. The internal memory is not affected by power interruption and requires no backup battery. Acid/base, pH/ORP interlock, function control and lockout switches are located behind the terminal block access panel.

The pH and ORP outputs are capable of handling 5 amps each at 120 Volt AC. The relay outputs are fused and transient protected. An internal terminal strip is provided for field wiring of the controller. The internal step-down transformer has a class-two energy limiting rating to provide for electrical safety.

**NOTE:** *When automating any body of water, it is essential to size the feeders to reach desired levels in a relatively short period of time. Generally, automating an existing body of water with existing feeders will require the output of the feeders be increased accordingly. If feeders are unable to keep up with demand in a short period of time, automation becomes ineffective.*

## 2.2 Specifications

ORP & pH Ranges	ORP	pH
Display:	0 to 995 mv.	6.8 to 8.4
Control:	400 mv to 900 mv (5 mv increments)	7.0 to 8.0
Factory default:	650 mv	7.4

### Input Power

120 Volts AC, 50/60 HZ, 3 wire grounded power cord.  
Combined load not to exceed 15 amps.  
GFCI source required

### Output Power

120 Volts AC, 50/60 HZ, ORP and pH -5 amps each (fused)  
Two 3-wire grounded power receptacles  
Terminal strip for hardwire applications (included)

### Displays:

ORP and pH – red digital  
Power and flow indicator - LED  
Alert indicator & Feed indicator- LED (ORP & pH)  
Mode indicator- LED (pH ,ORP , Auto)

NOTE- feed lamps flash during the feed time and are on constant during the delay time of the feed cycle.

Operating Temperature: 40 to 120° F

### Selectable Features

+ ORP and pH settings	+ High and low ORP and pH alerts	+ ORP and pH feed/delay times
+ Manual feed	+ pH calibration	+ Acid/base feed
+ Keypad Lockout	+ Adjustable time-out	+ ORP and pH Interlock
+ Reset		

### Features and Options

+ Flow switch input	+ Individually fused outputs	+ 120 vac transformer
---------------------	------------------------------	-----------------------

## 2.3 Description of Controls

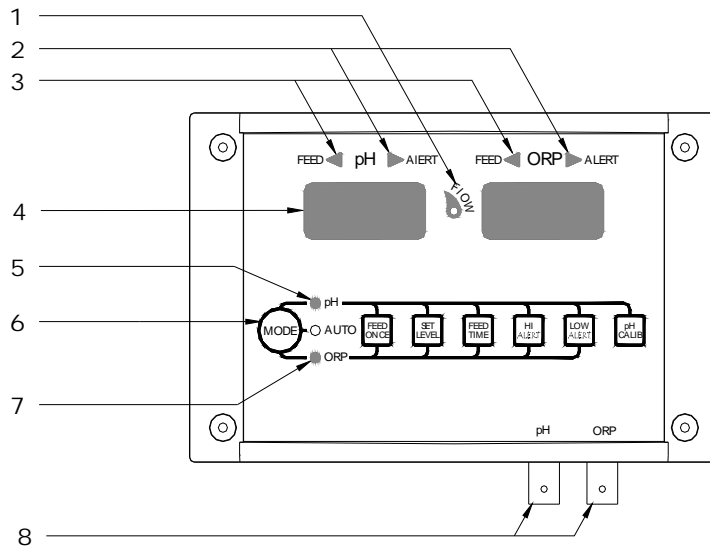

### 1. WATER FLOW LAMP

Illuminates bright when water flow is indicated. Also indicates that power is on.

### 2. pH/ORP ALERT LAMPS

Illuminates red when the Hi or Low Alert levels are reached.

### 3. CHEMICAL FEED LAMPS

pH FEED lamp flashes while feeding chemical and illuminates steady during feed delay.  
 ORP FEED lamp flashes while feeding chemical and illuminates steady during feed delay.

### 4. pH/ORP DIGITAL DISPLAYS

Monitors pH and ORP and displays programmed set points.

### 5. pH STANDBY LAMP AND PROGRAMMING BUTTONS

When pH standby lamp is illuminated the six set buttons are enabled.

### 6. MODE BUTTON AND AUTOMATIC LAMP

Press Mode button to pH or ORP and hold for 2 seconds for OFF.  
 Press and release Mode button to step from pH to ORP .  
 Press again to return to AUTOMATIC mode.

### 7. ORP STANDBY AND PROGRAMMING BUTTONS

When ORP standby lamp is illuminated the five SET buttons are enabled.

### 8. pH/ORP SENSOR CONNECTORS

**Modes:** The controller has four modes of operation:

- ON/OFF mode.
- AUTO mode- operating
- pH - setting mode
- ORP- setting mode

To move from one mode to another simply press the MODE button.

The illuminated lamp indicates the current mode.

### **On/off mode:**

- To turn the controller “on”, press the MODE button.
- To turn the controller “OFF” press and hold the MODE button for two seconds until both the pH and ORP displays read “OFF”. Release the MODE button and the controller turns off and the displays go blank.

Note: Turning the controller “OFF” using the MODE button simply turns off the controller functions, but does not turn off the power to the controller. The ‘FLOW’ lamp located at the center of the controller is both the power light and a flow indicator when an optional flow switch is used.

**AUTO mode:** This is normal operation mode. The controller operates the respective feeders to automatically maintain the parameters set for both pH and ORP.

**pH SET mode:** This enables the six programming buttons to set the desired pH parameters.

NOTE: When scrolling through the set modes, to reverse the direction simply release the button momentarily and press the button again.

**Feed Once button:** By pressing the feed once button, the pH feeder will feed and delay for one complete feed cycle. See Feed Time Button for feed/delay times. If the Feed time is set for “continuous feed” the manual feed will not operate.

**Set Level button:** Pressing the set level button once will display the current set level. To change the set level, press and hold the set level button (which displays in 0.1 pH increments) until the desired level is reached.

**Feed Time:** The feed times are displayed in seconds.

Each feed cycle includes a five (5) minute delay time. Pressing the feed time button allows the user to scroll through the available feed times. Release the button when the desired pH feed time is reached. To set the controller in constant feed, release the button when the display reads “con”.

**Note: Alert feature:** If the pH reading is out of the pre-set alert range for more than ten (10) minutes the pH red alert lamp will flash and the pH feeder will be disabled. The system will automatically reset when the alert condition has been cleared by itself or by an operator.

**Hi Alert:** Pressing the High Alert button allows the operator to set or turn off the HI alert level feature. As the button is pressed the pH readout will scroll through the available HI alert pH levels (7.8 to 8.4 and off). Release the button when the desired level is reached. The Hi Alert cannot be turned off in the BASE feed selection.

**Low Alert:** Pressing the Low Alert button allows the operator to set or turn off the Low alert level feature. As the button is pressed the pH readout will scroll through the available Low



alert pH levels (6.8 to 7.3 and off). Release the button when the desired level is reached. The Low Alert cannot be turned off in the ACID feed selection.

**pH Calibrate:** This button allows the operator to calibrate the pH sensor to a buffer or to a sample tested with a test kit. Pressing the pH CALB button allows the operator to set the pH reading to the desired pH level.

**NOTE:** The sample to be tested should always be taken from the flow cell or container in which the pH sensor is located. The pH calibration allows the adjustment of +/- 1 pH in .1 pH increments.

**ORP mode:** This enables the first five programming buttons to set the desired ORP parameters.

**Feed Once:** By pressing the feed once button, the ORP feeder will feed and delay for one complete feed cycle. See Feed Time Button for feed/delay times. If the Feed time is set for “continuous feed” the manual feed will not operate.

**Set Level:** Pressing the set level button once will display the current set level. To change the set level, press and hold the set level button (which displays in 5 m volts increments) until the desired level is reached.

**Feed Time:** The feed times are displayed in seconds. There is a five (5) minute delay time associated with each feed time. Pressing the feed time allows the user to scroll through the available feed times. Release the button when the desired ORP feed time is reached. To set the controller in constant feed mode, release the button when the display reads “con”.

**Hi Alert:** Pressing the High Alert button allows the operator to set or turn off the HI alert level feature. As the button is pressed the ORP readout will scroll through the available HI alert ORP levels (650 mv to 900mv, preset at 900 mv ). Release the button when the desired level is reached.

**Low Alert:** Pressing the Low Alert button allows the operator to set or turn off the Low alert level feature. As the button is pressed the ORP readout will scroll through the available ORP levels (100 mv to 640 mv in 5 mv increments and “OFF”). Release the button when the desired level is reached. The pH CALIB button is not functional in the ORP mode.

**Note: Alert feature:** If the ORP reading is out of the pre-set alert range for more than ten (10) minutes the ORP red alert lamp will flash and the ORP feeder will be disabled. The system will automatically reset when the alert condition has been cleared by itself or by an operator.

### 3.0 Installation

### 3.1 Locating the controller

Install the chemical pump and erosion feed systems as shown in manuals included with the feeders. The controller may need to be set for the particular feeder system used. Before installing the controller, it is important to do a site assessment to consider where and how you will mount the unit. The controller should be mounted on a wall or other surface within eight feet of the feeder, at least ten feet away from the edge of the water, and within six feet of the GFCI power source. Never mount a controller above or near an acid tank. See appendix for typical feed system schematics.

### 3.2 Mechanical Installation

Once the site is selected, obtain screws or anchors (mounting screws are not provided with controller) to securely mount the controller on the wall or a panel. Install a screw in the wall/panel where the top center of the controller is to be located. Leave ¼ inch of the screw out of the wall to hang the controller from the keyhole located on controller's back. Remove the power panel access cover and install screws through the two holes located at the bottom left and right corners of the controller. Leave the power access panel cover off.

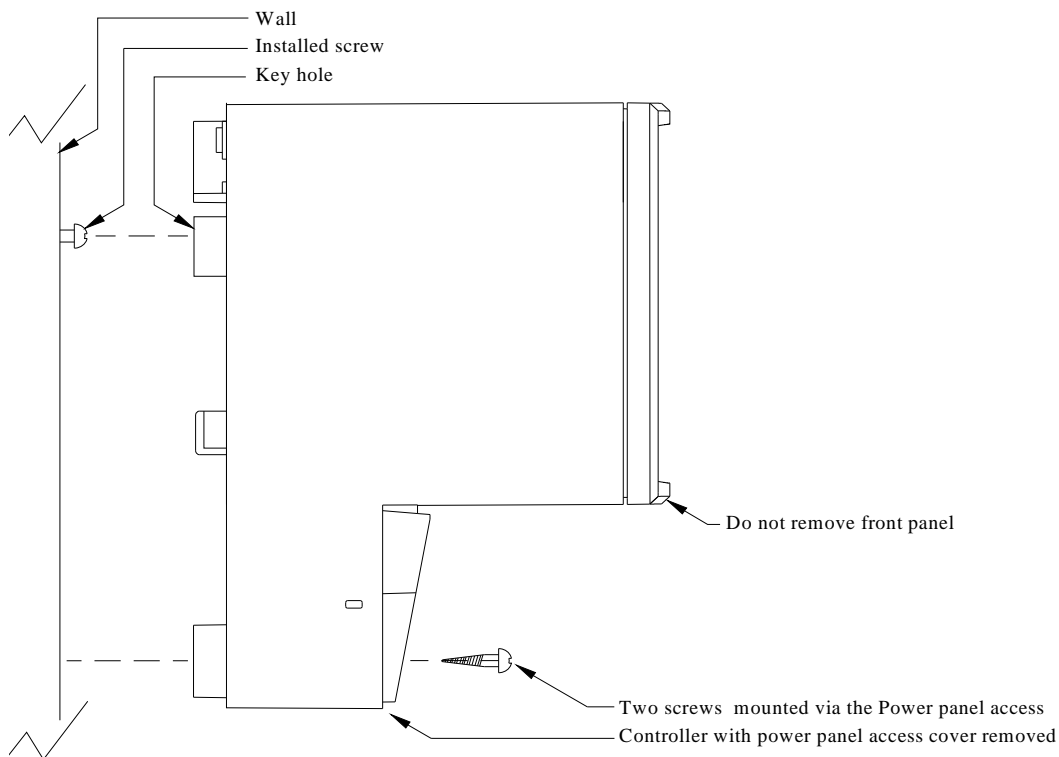

### 3.3 Power access Panel

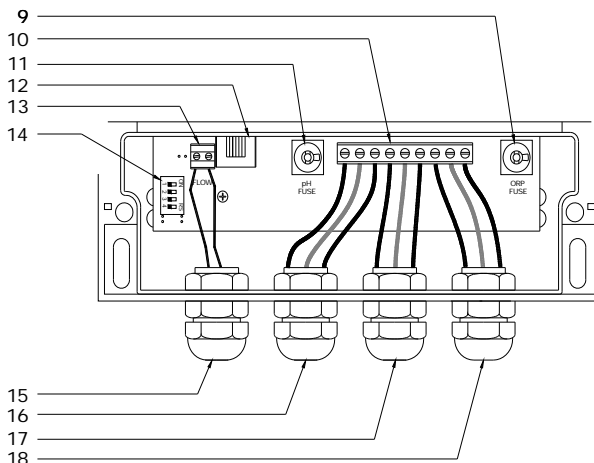

- 9. ORP FUSE
- 10. TERMINAL STRIP
- 11. pH FUSE
- 12. DATA PORT
- 13. FLOW SWITCH TERMINAL
- 14. DIP SWITCH ARRAY
- 15. FLOW SWITCH INPUT
- 16. pH OUTPUT
- 17. ORP OUTPUT
- 18. EXTERNAL POWER INPUT

#### 3.3.1 Dip switches

The controller has a series of dip switches to control functions that are not normally accessible on the front panel. These dip switches are located inside the Power panel. To access switches, remove power from the controller and remove power access panel. There are four dip switches- #1 is the top switch. The switch is 'off' when in the left position and 'on' in the right position. See appendix for settings.

#### 3.3.2 Fuses

The ORP and pH are independently fused to protect the controller from defective feeders. These fuses are located inside the lower panel. The fuse holders are shipped with 5 Amp fuses. (Replacement fuses are 5mm x 20mm Fast Acting IEC.)

#### 3.3.3 Flow Switch

The controller has a flow switch terminal located inside the lower panel on the left side. It is shipped with a 'jumper' in place. The terminal must either have the jumper or a flow switch installed.

The flow switch light on the face of the controller is also a power light that shows that the controller is connected to a live power source. If the terminal does not have a closed circuit, the controller will not turn on.

To install a flow switch, remove the jumper and install the flow switch leads. Note: with the flow switch installed and the jumper removed, the flow light will no longer operate as a power light. It is recommended the jumper be retained to assist in trouble shooting if necessary.

**NOTE: It is recommended that an inline filter be used to help keep the flow manifold (including probes) and flow switch free from debris (see Manifold Operating Manual). Debris may cause obstruction in flow switch and prevent the switch from functioning.**

## 4.0 Operation

### 4.1 Startup

Do not add chemicals to the feeders until all start-up operations are completed. Using a DPD test kit, manually adjust and balance the pool to acceptable ranges. Automation should be used to maintain chemical levels, not to balance a pool that is far out of acceptable ranges. With the controller in the OFF Mode, turn the filter pump on and check for leaks in the system and flow through the flow cell. The blue flow lamp will be illuminated if the controller has power, it is connected to the flow switch and there is adequate flow. If a flow switch is not attached, the flow lamp will be illuminated if there is a jumper in the flow cell connection (allowing the controller to be used without a flow switch). It is recommended that a flow switch always be used.

### 4.2 pH settings

Press and release the controller MODE button until the pH LED is lighted (refer to the description of controls). Then select the desired set level, feed time cycle, upper and lower alert levels. While still in pH mode do an initial calibration of the pH sensor. Always calibrate using water from the sample port of the flow cell, unless using preset buffer solution. It may take up to 24 hours before the sensors acclimate to the system so recalibrate 24 hours after the first calibration. The pH sensor can drift slightly over time and calibration will offset this drift. The pH sensor should be calibrated every four to six weeks.

Low feed rates can cause the feeder to lag or feeding to be extended. A high feed rate can result in too much pH chemical being added.

In constant feed, the feed lamp will flash while feeding. The feed lamp will not activate when the pH alert lamp is on (pH is below or above the alert settings).

If using time feed cycle, the feed lamp will flash during the feed time and be constant during the delay time of the feed cycle.

To verify the feed type (acid or base) adjust pH “set” level above the pH indicated on display. The feed lamp should come on if the controller is in acid feed mode. If the controller is in base feed, the feed lamp will come on if the pH indicated is below the pH “set” level.

### 4.3 ORP settings

The controller displays direct ORP readings and the sanitizer level controlled by this reading. The ORP display indicates the effectiveness of the sanitizer; it does not directly correlate to a chlorine ppm reading. Use a DPD test kit to measure the free chlorine. Adjust the ORP Set Level to the desired level. If desired, set the OPR level to correspond to the OPR reading when the water is balanced to the desired chlorine ppm.

Press and release the controller MODE button until the ORP LED is lighted (refer to the Description of Controls section). Then select the desired set level, feed time cycle, high and low alerts

### 4.4 Operating mode.

Press and release the MODE button until the "AUTO" LED is lighted. This is the operational mode for the controller. The controller must be in this mode for the feeders to maintain the desired parameters. Consider recalibrating the system after the initial 24 hours as the sensors acclimate to the system. If the sanitizer level is too low or high, adjust the feed level up or down in small increments, (for example 10mv to 25 mv increments) to lock in the desired sanitizer level. However, prior to adjusting the ORP level, check pH level and adjust/recalibrate the pH if necessary.

Note: the ORP reading is highly dependant on both the pH and the cyanuric acid levels. Both of these variables must be kept within acceptable ranges to maintain an acceptable relationship between the ORP and the ppm of the sanitizer.

Note: When using the 55400 controller with Rola-Chem pumps, the pump switch should be in the ON position (not Timed or Off).

## 5.0 Troubleshooting-

### A. Chemicals not feeding

- \* FLOW light on Controller must be illuminated.  
Check flow switch (manifold) if light is not on (Section 3.3.3)
- \* Feeder power and time switches must be in 'ON' position.  
Check feeder by using alternate power source.
- \* Factory setting for feed time is 0.6 sec on with 5 minute delay.  
Feeders may require longer feed time.

## **B. Displayed chemical level don't correspond to actual**

- \* ORP=0, pH=6.8 indicates sensors (probe) are attached to incorrect connector
- \* Sensors (probe) need cleaning.
- \* Sensors (probe) need replacing.

Note: OPR probe reading can be affected by pH probe.

Both probes must be in good operating condition.

## **C. Set-points not being reached/maintained**

- \* Factory setting for feed time is 0.6 sec on with 5 minute delay. Feeders may require longer feed time. If time is too short, set-points will not be maintained. If time is too long, overfeeding chemicals will occur. Correct time is dependent of multiple factors such as pool/spa water volume, feeder output, chemical concentration and chemical needs.
- \* Controllers are designed to maintain set-points. Do not expect Controllers to make major adjustments—major changes should be done manually.
- \* Pump/feeders must be large enough to reach desired set-points in a relatively short time. Automation using controllers may require larger feeder or more concentrated chemicals than system that uses continuous time controlled feeding (i.e. feeders only).

## **6.0 Warranty and Service-**

### **Limited Warranty:**

Rola-Chem Corporation warrants the original purchaser that this unit is free from manufacturing defects in material and workmanship from the date of the original purchase for one (1) year.

If this unit fails within the one (1) year period, it will be repaired or replaced (Rola-Chem's option) at no charge, when returned to Rola-Chem Corporation with proof of purchase receipt. This warranty does not apply to any product damage caused by improper use, accident, misuse, improper line voltage, fire, flood, lightening, earthquake or other acts of nature, or, if product was altered or opened by anyone other than qualified Rola-Chem personnel.

All expendable items- hoses, etc., are not covered under this warranty.

Heavy duty probes are warranted from the date of original purchase for one (1) year.

Rola-Chem Corporation, under no circumstances, shall be liable for any consequential damages directly or indirectly caused by this unit. Please observe all rules and regulations required by state and local regulations, building codes, health codes, OSHA, etc.

### **Service Procedure:**

For operation assistance in the United State, please call:

(800) 549-4473 or FAX (651)-653-0989

Monday thru Friday 8:00 am-5:00 pm, Central Time.

Rola-Chem Corporation has specialized knowledge and equipment to properly test your unit and help you with special problems. After talking to our service personnel, the product in need of service should be shipped with RGA#, freight prepaid, via UPS if at all possible to:

Rola-Chem Corporation  
5858 Centerville Road  
St. Paul, MN 55127-6804

## 7.0 Appendix

### 7.1 Dip switch settings

The controller has dip switches to control functions/options that are not accessible on the front panel. These dip switches are located inside the power access panel. See section 3.3.

It is recommended that switches #1 and #2 be in the ON position.

Control	Switch	Description
ORP/pH interlock	#1 OFF #1 ON	ORP chemical feeding is independent of pH feeding and range.  ORP chemical feed only when pH is within limits. ORP will not feed when pH chemical is feeding.
Feed mode limit - <u>Timed</u> feed Mode (Time set on front panel)	#2 OFF #2 ON	There is no consecutive feed limit.  The pH & ORP chemical feeder outputs go through a preset number of consecutive feed cycles before feeders are disabled. If preset count is reached for either pH or ORP, the respective feeder outputs will be disabled and its display will flash.  The number of consecutive feed cycles is 3 to 20 (default is 10) and can be independently set for both pH and ORP.  <u>To adjust the time out feature in the 'timed feed mode'</u> 1) Turn off & remove power, then move #2 dip switch to ON. 2) Re-power & press MODE to set it for ORP or pH 3) Set FEED TIME to OFF 4) Press FEED ONCE to select the feed count 5) Press FEEDTIME and return the time to the desired cycle
Feed mode limit - <u>Continuous</u> feed Mode (Time set to 'con' on front panel)	#2 OFF #2 ON	There is no consecutive feed limit.  The pH & ORP chemical feeder outputs continuously feed for a preset time before feeders are disabled. If the preset time period is reached for either pH or ORP, the respective feeder output will be disabled and it's display will flash.  The time out period can be set from 10 to 99 minutes (default is 10 minutes) and can be independently set for both pH and ORP.  <u>To adjust the time out feature in the 'continuous feed mode'</u> 1) Turn off & remove power, then move #2 dip switch to ON 2) Re-power & press MODE to set it for ORP or pH 3) Set FEED TIME to 'con' 4) Press FEED ONCE button to select the default feed time
Acid/Base pH chemical feed	#3 OFF #3 ON	Unit set to feed acid chemical when pH is over set-point  Unit set to feed base chemical when pH is under set-point
Keypad Lockout	#4 OFF #4 ON	Key pad operable to set controller parameters  Key pad operable only for pH calibration. Other parameters stay at settings established prior to moving dip switch #4



## 7.2 Factory Default Setting

**Reset:** The controller can be reset at any time to the default factory settings.

The factory presets are:

ORP set level: 650mv  
pH set level: 7.4  
ORP alerts: high- 900 mv, low- 100 mv  
pH alerts: high- 8.0, low- 7.0  
Feed time: 0.6 seconds

To reset default settings, follow these steps:

A. Turn the controller Off:

Press 'MODE' to ORP or pH and then hold 'MODE'

Only flow light should be on.

B. Simultaneously depress and hold 'SET LEVEL' & 'pH CALIB'  
and while they are depressed, push 'MODE'

The displays will read "Ld" and then turn On.

C. Release the "SET LEVEL" and "pH CALIB" buttons.

D. Turn the controller Off again and then On.

The last step is extremely important since this puts the controller back in the operating mode. If step "D" is not performed the controller is in the test mode and it will not operate properly.

## 7.3 WATER CHEMISTRY RANGES

**(These ranges are in accordance with suggested NSPI Standards for swimming pools.)**

**pH:** 7.4 -7.6

**Alkalinity:** Approx. 80-120 ppm \*\* (parts per million)

Higher levels may be acceptable in areas where it naturally occurs in the local water supply.

Consult a pool professional in your area.

**Cyanuric Acid:** 0-50 ppm.

(Maintain at 30 ppm or less for best probe life.)\*

**TDS (Total Dissolved Solids):** 300 - 2000 ppm

**Calcium Hardness:** 200-400 ppm

**Free Chlorine:** 1.0 - 3.0 ppm (> 700 millivolts ORP)

\*20-30 ppm of cyanuric acid provides approx. 95% of the shielding effect for chlorine.

\*\*When using tri-chlor, recommended alkalinity is 95-125 ppm.

## 7.4 Typical System Installations

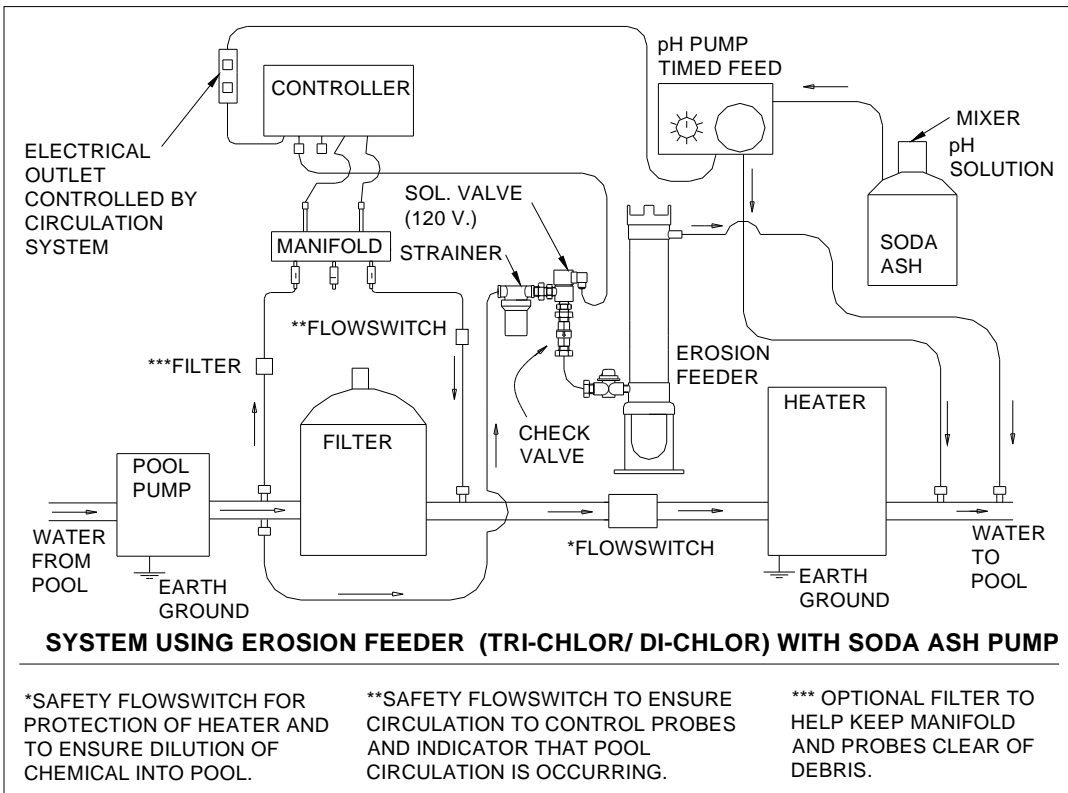
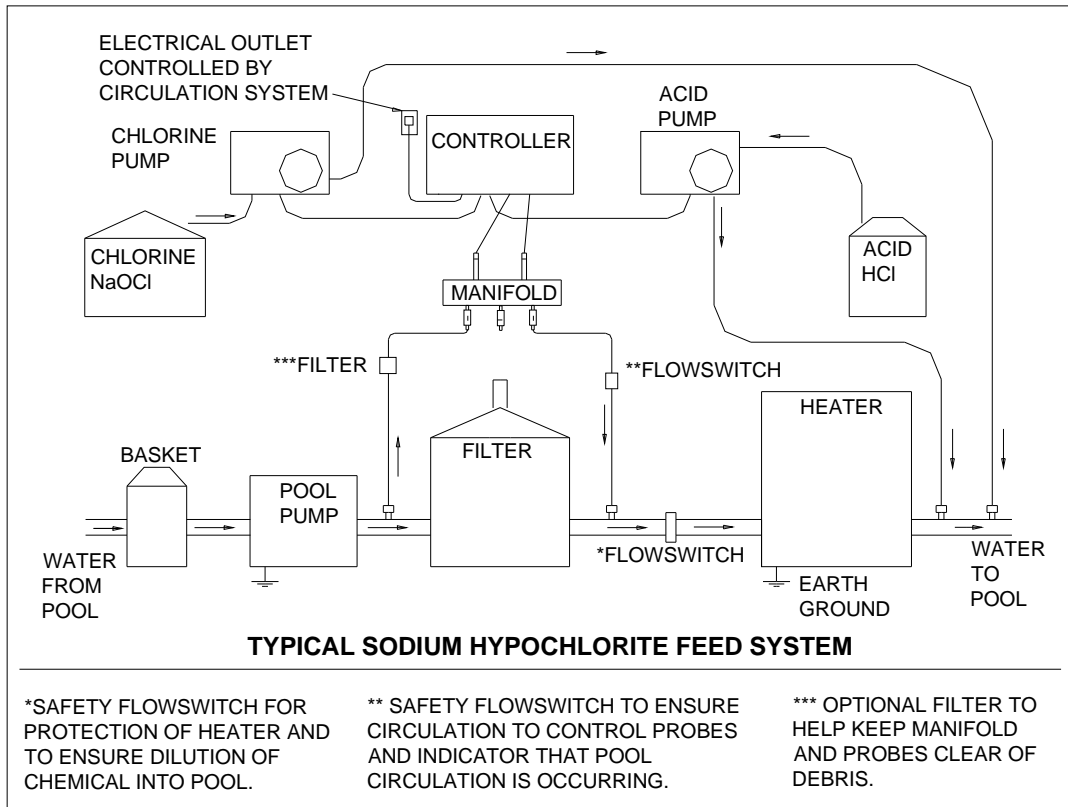

## 7.4 Typical System Installations, cont.,

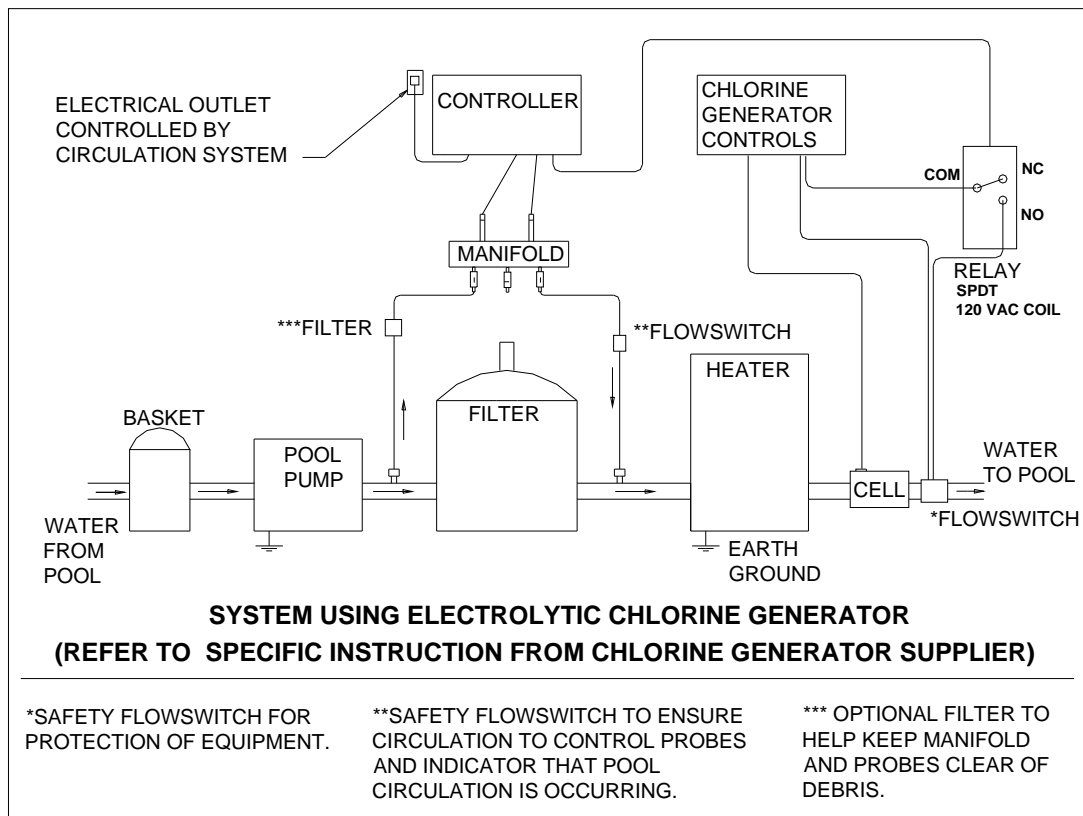
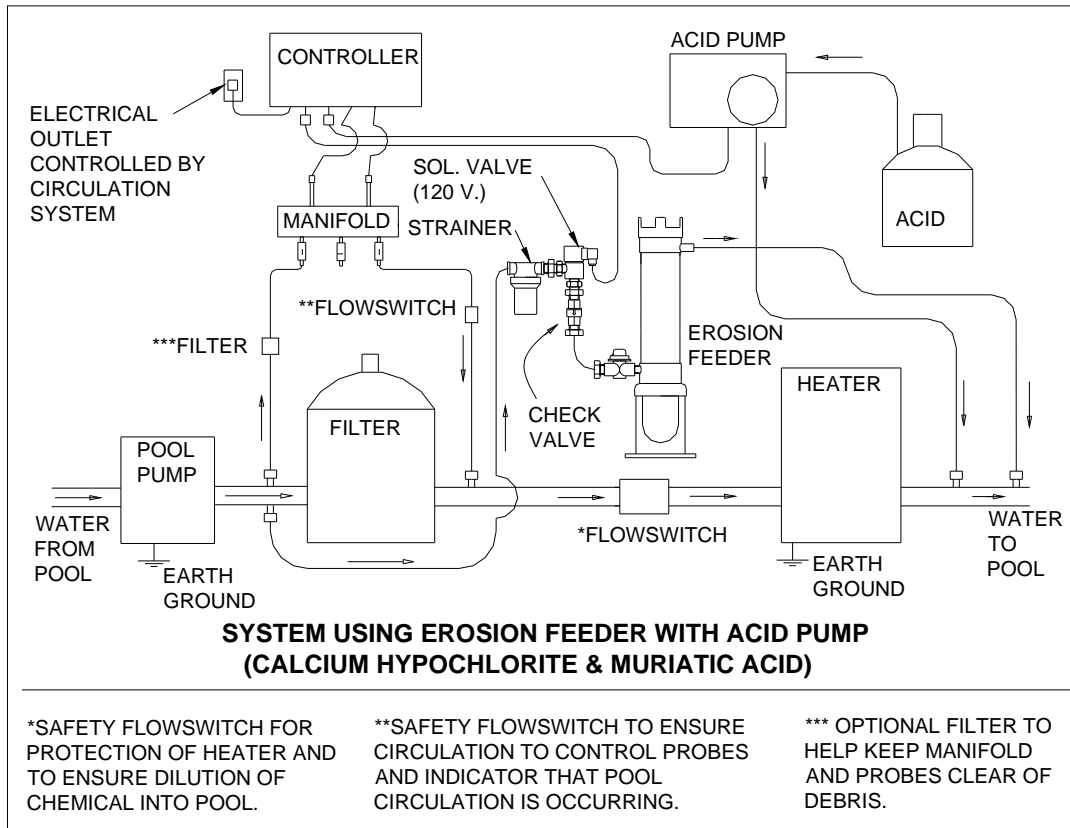

**-NOTES-**